

CS 3651 Project Brainstorming Ideas – Spring 2011

Would you like to know.....

If the package you purchased online has arrived?

if your mail was just put inside the mailbox?

if someone is at your door?

All in real-time!



By: Paul Beresuita

Then...

A solution is to have sensors and a device that alerts you of these different events

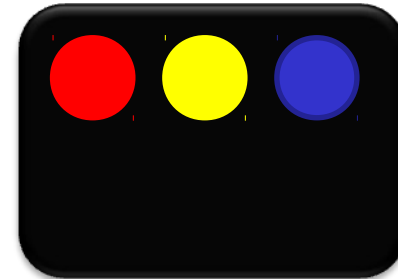
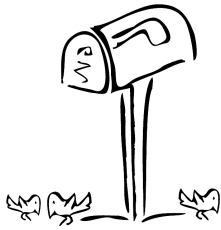
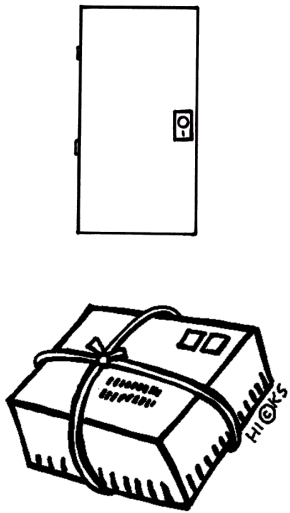

A better solution: In addition to the device, you will be sent an email notification or text!

Team: Will require 3 people—1: Experience with circuits
2: Programming experience
3: Programming experience

Laser Trip-Wire Alarm System

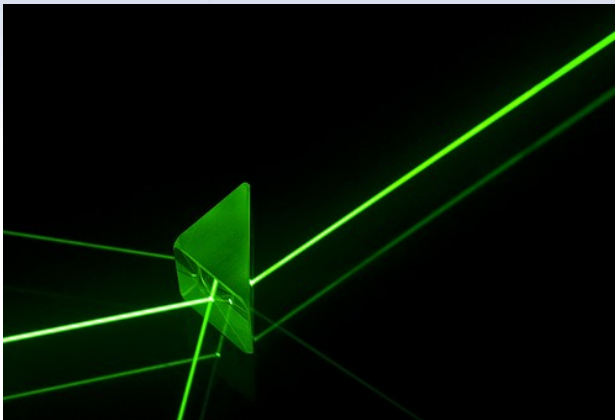
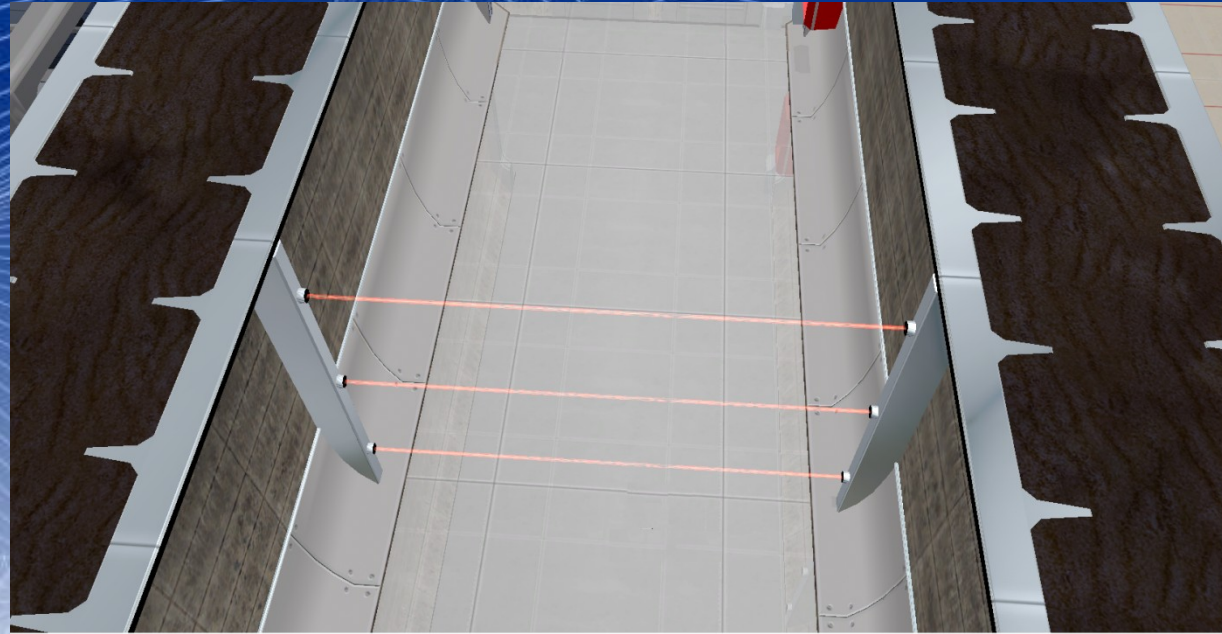

Lecture Title

- Goal: Protect the Precious!
 - Create a laser-tripwire perimeter around the precious.
 - Create a circuit that would trigger an alarm or notify someone through other means (a phone call or text message perhaps).
 - If the laser perimeter is broken, it is detected by the circuit and triggers the alarm sequence or any other means of notification and maybe takes a picture of the intruder using a camera.
 - Inspiration from Kip-Kay's video:
<http://www.youtube.com/watch?v=t0FTzUhdg3w>

Multitouch Jacket

- Problem: You want to change the song on your mp3 player but it's inconveniently located in your pocket.
- It would be nice to have an external interface to your device that was small and simple.
- Solution: Create a jacket that allows the user to interface with a multitouch interface made of conductive thread. Use gestures to control functionality to minimize the size of the touchpad and eliminate the need for multiple buttons.
- Henry Dooley

John Dugan – Beverage distribution device

- Goal: deliver appropriate beverage to user using mobile connection/app
- User can select from available beverages, check supplies, take recommendations based on time of day, and receive beverages without the hassle of excessive physical movement.
- Actually delivering the beverages to users could be achieved by a wheeled robot, or a rail system to roll/slide the beverage to an end location nearest to the user.

Party Mood Lighting System

Daniel Farmer

- A system that will provide soft mood lighting for a room
- Consists of
 - A light emitting tube (LED or Fibre Optic)
 - A control system with an input control and microphone
- Able to be set to a specific colour and brightness
- Able to listen to the beat of music in a room and change colour/flash in party mode
- Potentially extensible to include other light fixtures or video output

Home Keyless Entry - Edric Chen

- Problem: Getting into your house with groceries in hand is a chore and I want to stop having to put down all my bags and search for my key.
- Solution: Keyless entries for homes are not new, but they are expensive. My goal is to create a cheap solution to this problem.
- Extra Features: Along with keyless entry we can have some other entry features such as voice commands.
- Supplies: We will need a new door knob set and some type of remote device, preferably an existing car keyless entry remote or a bluetooth radio. Not quite sure what the cheapest way to do this is, especially while keeping the security of the house as priority number 1.

Ethan Landress – Fingerprint Attendance System

- Paper based attendance checking is slow and annoying
 - Use a fingerprint scanner near the class entrance to check each student as he or she enters
 - Collect a print for all students, store on a local PC, provide basic UI and admin options to professor
- Pros
 - Fast, will not interrupt class time
 - Provides easy to read records; no need search labs to see who was in class
 - Plenty of additional features possible
- Cons
 - Unexpected injury to finger?
- Skills
 - Sensing
 - Data storage/manipulation
 - UI Creation



Bruce Xu - Unlocking Electronic Deadbolt Lock Wirelessly

- Problem: Sometimes you forget your keys or someone forgot something at your house but you're not home. Maybe your friend is at the front door but you're too lazy to go unlock it while they are standing out there in the freezing cold.
- Solution: Build a lock that has wifi access so that you are able to remotely unlock the door using your phone or computer.
- Variations: The door may even include a vid cam so that you can see who's at the door before unlocking. Vid cam can be triggered by a motion detector or maybe even a door bell.
- Skills: Project may need 4 people with vast knowledge in network protocols, programming, and circuits.

Final Project Idea - Chayong Lee

- Good Boy
 - Lie Detector
 - An electronic device used to detect lying
 - Small, Portable, Easy to use
 - How to detect lying?
 - Voice analysis
 - Resistance of skin
 - Blood pressure
 - Eye blinking
 - Even more
 - I am looking for group members who
 - Like my idea and want to work on this
 - Have a background with electronic circuit and product design

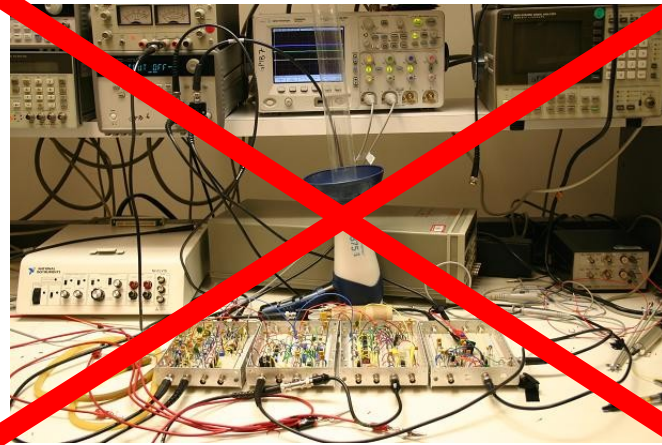

Simple Lie Detector – Joe Zhou

- How it works:

It works by measuring skin resistance, which goes down when you lie. It is essentially detecting changes in a person's conductance. Our body always conducts (n) degree electricity, and when there is moisture (sweat in this case) -- this degree of conductance increases. When a person is lying, their body produces sweat, and this circuit picks up on this.

- How to use:

Attach the electrodes to the back of the subjects hand, about 1 inch apart. Then, adjust the meter for a reading of 0. Ask the questions. You know the subject is lying when the meter changes or indicated by the different LEDs

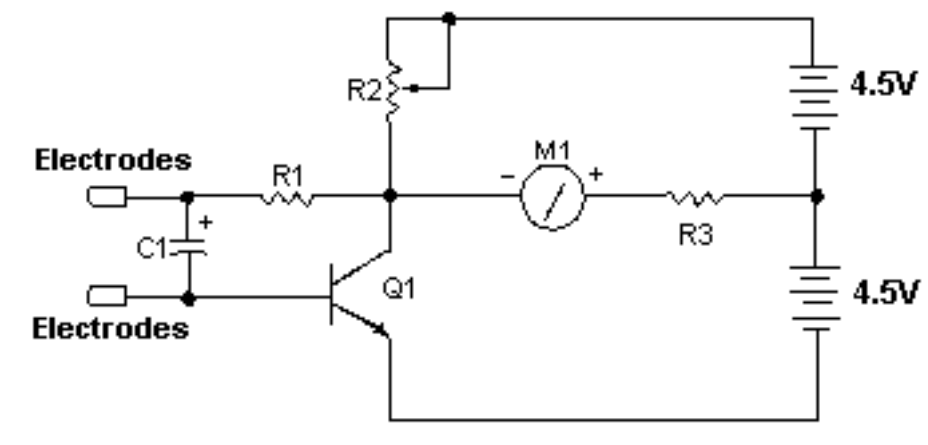

Realtime Faucet Adjuster



Problem: I can never figure out in what angle(s) I have to turn the faucet handle(s)/knob(s) to get the temperature that I want, and the temperature changes over time because either the hot water has to come through the pipes, hot water is running out, my neighbor started using it or someone flushed the toilet and it takes me forever to get the right temperature when I'm trying to wash my hands or face.

Solution: Why don't we make an automatic faucet handle angle adjuster that adjusts the angle real time? The user can input his/her favorite water temperature using a number pad or have a few preset temperatures. A temperature sensor will sense the water temperature and there will be an arm adjusting the angle accordingly. There could also be a display that shows the set temperature and the current temperature so you don't actually have to feel the water to see if it's already adjusted correctly. There will be a tolerance range of maybe ± 5 degrees or so and the machine will notify the user if it is not possible to get the input temperature may be because the water heater is not working. There will be a few seconds of waiting period at the beginning in case we need to wait for the hot water to come through the pipes

- ▶ We would probably need some ECE 2031 skills and programming skills
- ▶ 3-4 people should be enough
- ▶ **Kyung Ho Lee - klee43@mail.gatech.edu**

Final Project Idea – Semi-autonomous Assistant

- **Problem:** Making an entrance is an important part of impressing an audience. More and more people today give talks on how cool and important new technology is, yet these presenters lack a device to immediately set a precedent for how amazing new technology really is.
- **Solution:** Build a semi-autonomous device that will follow its 'handler' at a distance selected by the handler. This would provide a novel means to transport supplies that the handler may need for his or her presentation or just to help make a memorable entrance.
- **Skills:** RF Signaling, Distance sensing, metal working



John Madden

Idea: Redesigning the N64 (Gaurav Mathur)

- Most people grew up playing the N64 as a kid.
- Some of us go through bouts of nostalgia where we find ourselves replaying these games.
- But, the N64 takes a lot of patience to use.
 - Some find the controllers awkwardly shaped
 - The cartridges are always a pain to put in
- I suggest:
 - Redesign of the controller to model a more recent controller
 - A new housing for the N64 console
 - Perhaps portable
 - Easier/more reliable to put cartridges into
- Inspiration: N64p by Ben Heck



Sheet Music Turner

- Who:
 - Andrew Nemchik
- What:
 - A device that is able to turn sheet music with a hands-free trigger
- Why:
 - Allows for musicians to flip music on their own without stopping.
- How:
 - Take jukebox design
 - Adapt to music stand
 - Trigger with foot-pedal



Versatile Alarm Clock Mudit Manu Paliwal

- Lot of people have trouble waking up in the morning
- Design an alarm clock that pulls the blinds up to let in sunlight
- Up/down button to move blinds
- Wireless interface to set alarm clock via PC, cell phone etc.
- Display to show your schedule for the day.

1: Gumball Machine / Vending Machine – Mi Seon Park

- Materials Needed:
 - Glass or plastic for casing
 - Chains for moving cans
 - Controller for detecting coins



2: LED Clock

- Materials needed:
 - PIC microcontroller
 - LEDs
 - Panel
 - Battery



Keyless entry using your phone – Meet Patel

- Text to open/close the lock
- Solution
 - Part 1
 - Web-server which accepts text messages
 - USB bit whacker
 - Part 2
 - Servo Motor
 - Lock

Hanging LED Display – Tim Pincumbe

- This is basically a grid of LED lights that when turned on will form a pattern. It can possibly be text or just a funky looking pattern.
- The display can be 2 dimensional or possible 3 dimensional if there is enough time.
- This will probably need between 2 – 4 people to accomplish.

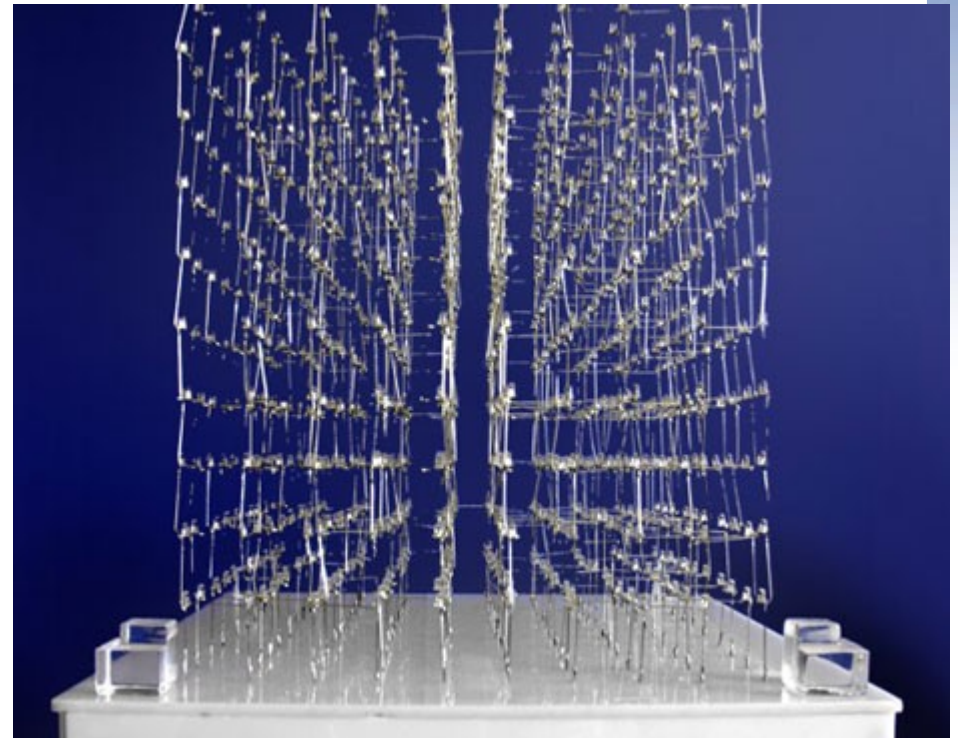

Aug 29 2007

Sound Beam Laser Hat – Halley Profita

would like to create a scarf or hat that receives audio information from a beam of sound that travels through the air via a light source.

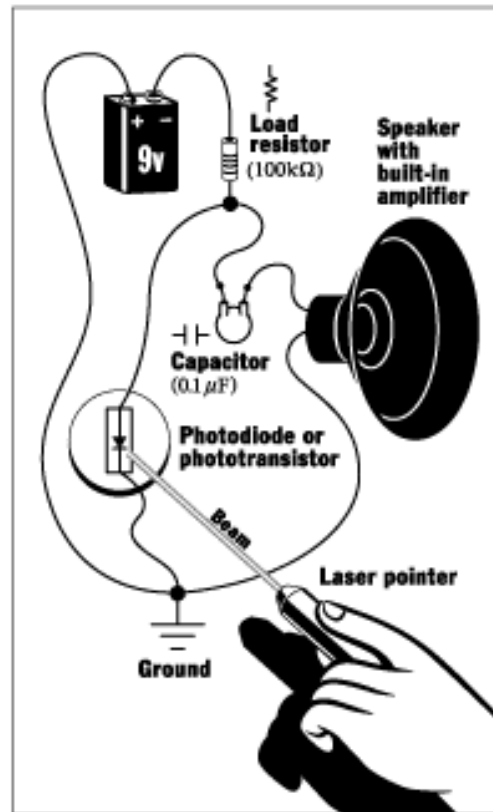
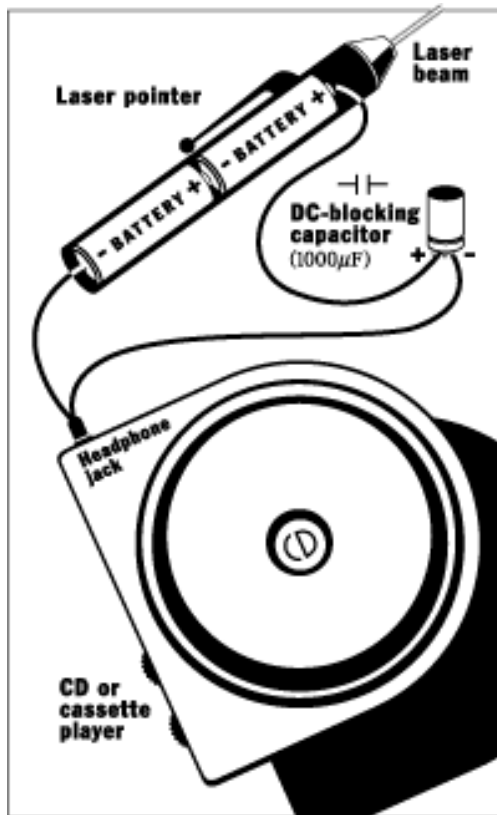

- I think this project will require about 2 to 3 people, more if we do multiple laser beams.
- I will need someone with knowledge of audio frequencies and electronics.

Party Noise Warning System - Hans

- From time to time some students like to have a good time with their friends in a dorm room or apartment.
- Sadly neighbors do not always appreciate the ability of college students to stay up late hours in the night and still be functional the next day so call the cops to ensure that the students get an appropriate amount of sleep.
- The Party Noise Warning System would help prevent such sad misunderstandings by warning a host that the decibel level of their party is approaching dangerous levels by flashing a warning light and turning down the music if possible.
- This would be a 2-4 person project and would require basic circuit skills, strong programming skills, and possibly mechanical skills depending on what method is decided upon to turn down music.



Lauren Schmidt – Automatic Animal Deterrent

- Problem: Neighbors' pets entering home from outside or household pets entering forbidden rooms inside
- Solution: Automatic water gun. Senses if an animal between a certain height is crossing the path, squirt it with water.
- Height can be adjusted to keep out dogs but allow cats (or any other arrangement)
- Two sensors means that anything taller (humans) will not be sprayed every time they pass through the sensors.



Home Control System – X9000+ - Shroff Abhishek

- X10 is currently the dominant standard for home automation and control
 - It was developed in 1975
 - Security wasn't a prime focus
 - Doesn't support metadata
 - In fact, it doesn't support anything other than predefined signals
 - Appliances are not aware of the presence
- Build new protocol and accompanying device(s) that take care of the listed deficits
- Will need a fairly diverse group of 3 – 4 students preferably experienced with microcontroller design.



LED Bicycle Wheel Display – Russell Strauss

LED Bicycle Wheel Display – Russell Strauss

- customizable text or designs
- Pictures
- Detects the speed of the wheel and blinks LED's accordingly to display correctly
- Possibly multi-colored LED's
- The extra mile:
 - GUI for user interaction



PC and TV Integration - Jinghui Wang

Description: Integrate flat screen TVs with computer.

Application: Entertainment system and digital signing.



Ball Throwing Machine -BoHao Li

- Dogs enjoy playing fetch
- People often don't have enough time to play with their pets

Ball Throwing Machine

- The machine will throw balls randomly within the area specified by the owner
- Dogs will fetch the ball and bring it back to the machine
- Machine then reloads and throws again

